

## SPECIFICATIONS

**CONTACT RATING:** AC 125V 6A, AC 250V 3A ,DC 30V 3A

**MECHANICAL LIFE:** 100,000 make-and-break cycles  
DC 10V & 0.1mA.

**CONTACT RESISTANCE:** 10 mΩ max.

**INSULATION RESISTANCE:** 500V 500 MΩ min.

**DIELECTRIC STRENGTH:** 1,000 Vrms min. @sea level.

**OPERATING TEMPERATURE:** -30°C to 85°C.

**WATER-RESISTANCE:** 100 make-and-break cycles min at 10 cm depth for T12 actuator.

## MATERIALS

**CASE:** Diallyl phthalate (DAP) (UL94v-0).

**ACTUATOR:** Brass,chrome plated.

**BUSHING:** Brass,nickel plated.

**HOUSING:** Stainless Steel.

**SWITCH SUPPORT:** Brass,tin plated.

**TERMINAL/CONTACT:** Brass,with silver or gold plated.(See Page 23)



1F  
Toggle Switches

## HOW TO ORDER

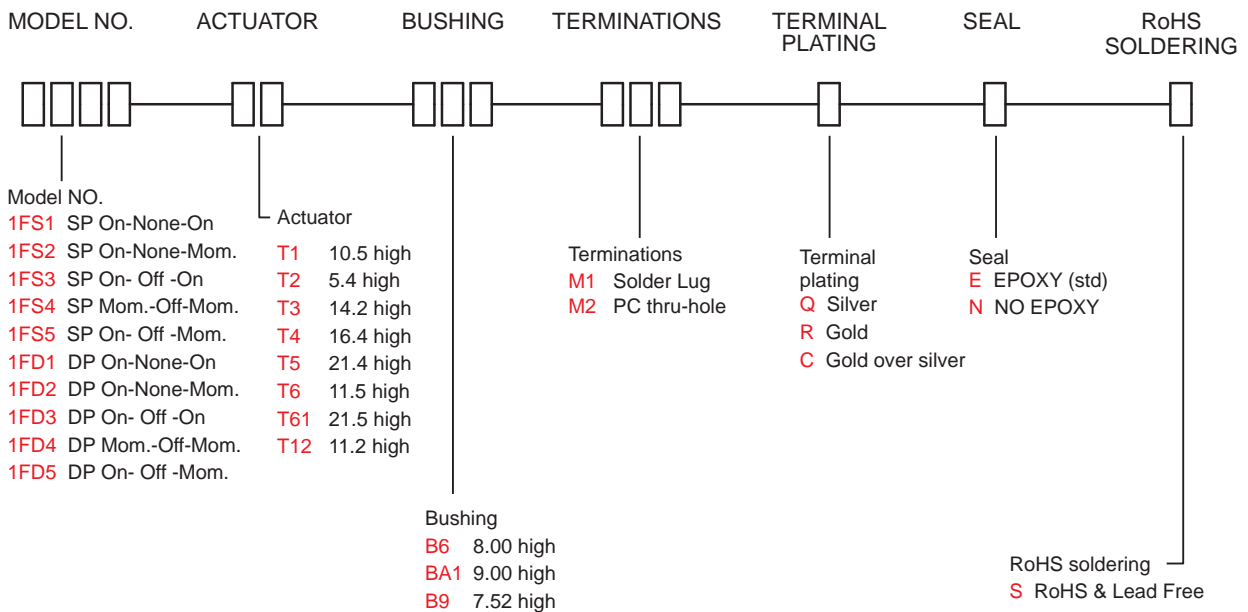

# 1F Series

Miniature Toggle Switches

## SWITCH FUNCTION

NO. POLES	MODEL NO.	SWITCH FUNCTION			CONNECTED TERMINALS / SCHEMATIC					
		POS.1	POS.2	POS.3	POS.1	POS.2	POS.3			
SP	1FS1	ON	NONE	ON	2-3	N/A	2-1			
	1FS2	ON	NONE	MOM						
	1FS3	ON	OFF	ON						
	1FS4	MOM	OFF	MOM					OPEN	
	1FS5	ON	OFF	MOM						
DP	1FD1	ON	NONE	ON	2-3,5-6	N/A	2-1,5-4			
	1FD2	ON	NONE	MOM						
	1FD3	ON	OFF	ON						
	1FD4	MOM	OFF	MOM					OPEN	
	1FD5	ON	OFF	MOM						

MOM=MOMENTARY

## ACTUATOR OPTIONS

T1 STD

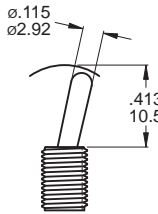

T2

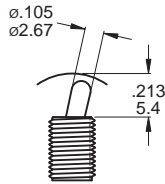

T3

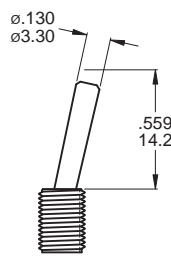

T4

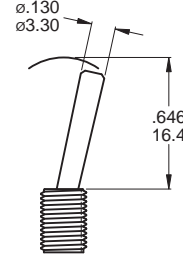

T5

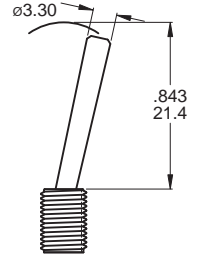

T6 FLATTED WITH ANTIROTATION

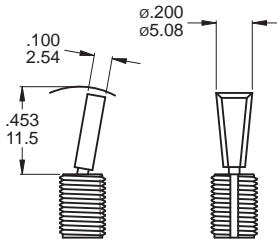

T61

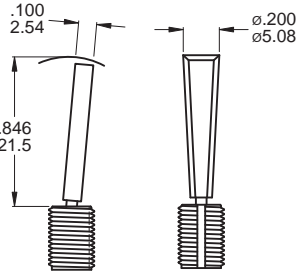

T12

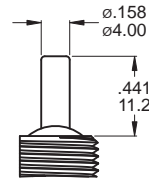

T12 use with BA1 bushing only  
\*T12 actuator mechanical life 200,000 cycles

T6,T6-1 use with B6 bushing only

## TERMINATION OPTIONS

M1 Solder lug

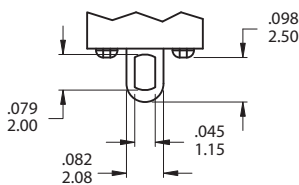

M2 PC Thru - hole

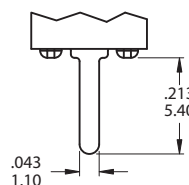

BUSHING OPTIONS

B6 HIGH TORQUE

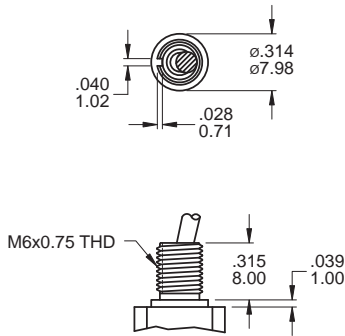

B9 SPLASH PROOF

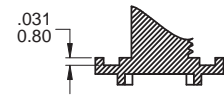
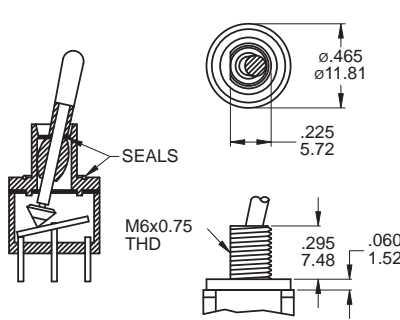

CP-1TEB

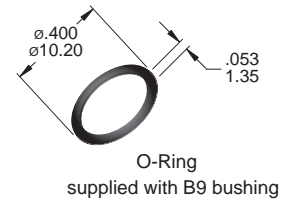

BA1 SPLASH PROOF

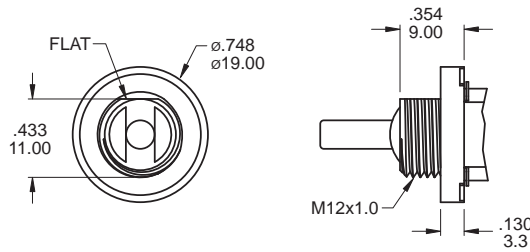

Use with T12 actuators only  
BA1 Bear Strength from top of actuator  
up to 10kg aside up to 15kg

POLE OPTIONS

SPDT

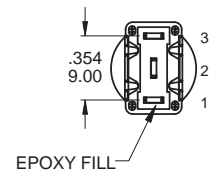
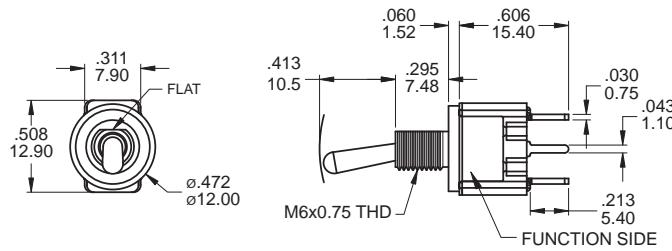

Part No. Shown : 1FS1T1B9M2RES

DPDT

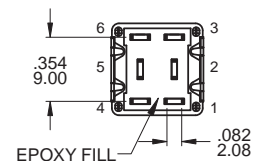
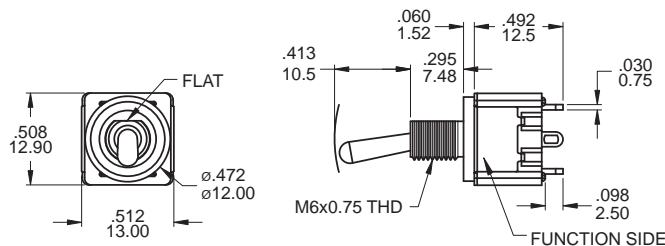

Part No. Shown : 1FD1T1B9M1QES



1F  
Toggle Switches

# 1F Series

Miniature Toggle Switches

1F  
Toggle Switches

## SPDT

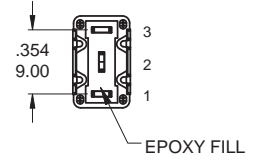
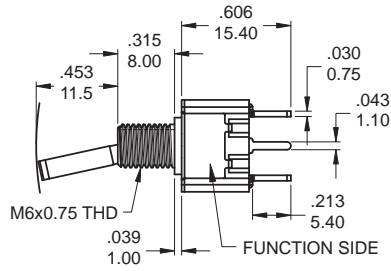
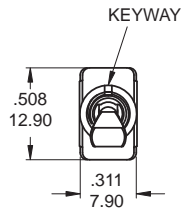

Part No. Shown : 1FS1T6B6M2QES

## DPDT

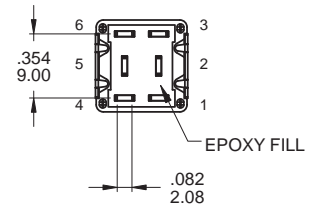
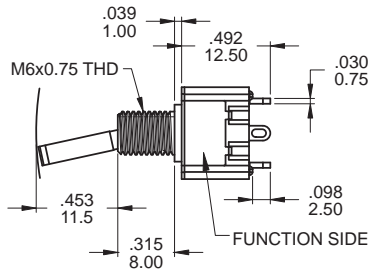
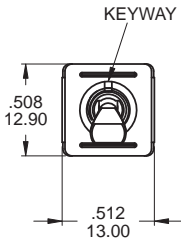

Part No. Shown : 1FD1T6B6M1QES

## SPDT

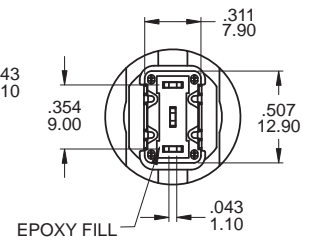
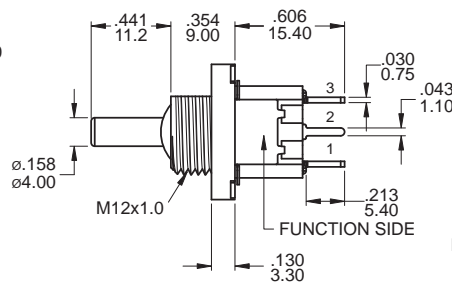
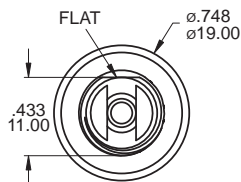

Part No. Shown : 1FS1T12BA1M2QES

## DPDT

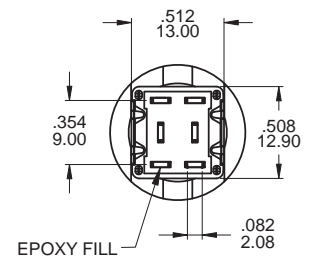
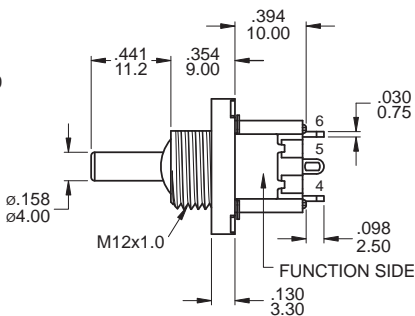
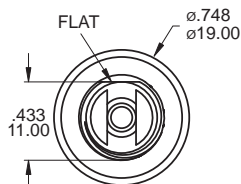

Part No. Shown : 1FD1T12BA1M1QES

**HARDWARE**

**M6x0.75 NUT**

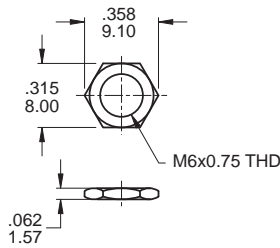

**MNU-1M04**

**LOCKWASHER**

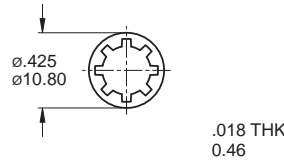

**MNU-1M03**

**LOCKING RING**

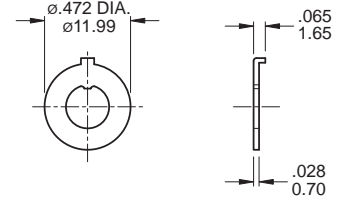

**MNU-1M05**

**M12x1 NUT**

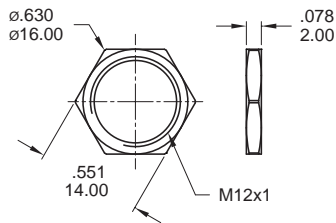

**MNU-1M42**

Supplied standard with BA1 bushing

**LOCKWASHER**

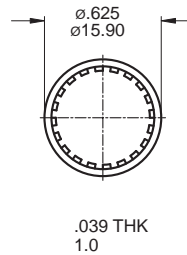

**MNU-1M09**

Supplied standard with BA1 bushing

**O-RING**

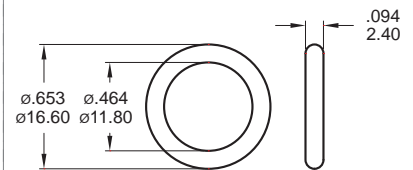

**FCP-1F04**

Supplied standard with BA1 bushing

**CONTACT MATERIAL OPTIONS**

	<b>CONTACT PLATING</b>	<b>TERMINAL PLATING</b>	<b>RATINGS</b>
<b>Q</b>	Silver	<b>Q</b> = Silver	6 Amps with resistant load @ 125VAC 3 Amps with resistant load @ 250VAC or 30VDC
<b>C</b>	Gold over Silver	<b>C</b> = Gold over silver	
<b>R</b>	Gold	<b>R</b> = Gold	0.4 Volt - Amps ( VA ) max. @ 20V max. ( AC or DC )

**SOLDERING PROCESSES**

**MANUAL SOLDERING** : Use soldering iron of 30 watts, controlled at 350°C approximately 5 seconds while applying solder.

**WAVE SOLDERING**: Recommended Soldering Temperature: 270 ± 5°C

Duration of Solder Immersion: Max 5 sec. (PCB is 1.6mm in thickness)



1F  
Toggle Switches